

TR443

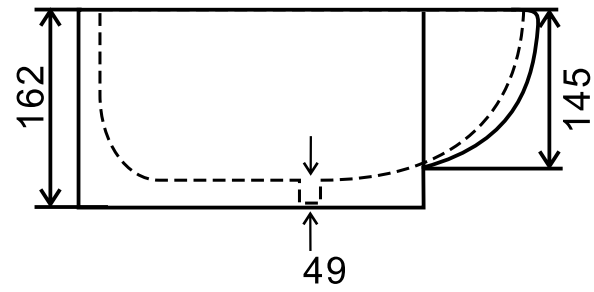
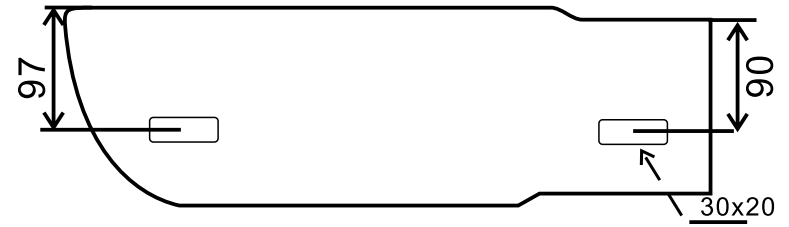
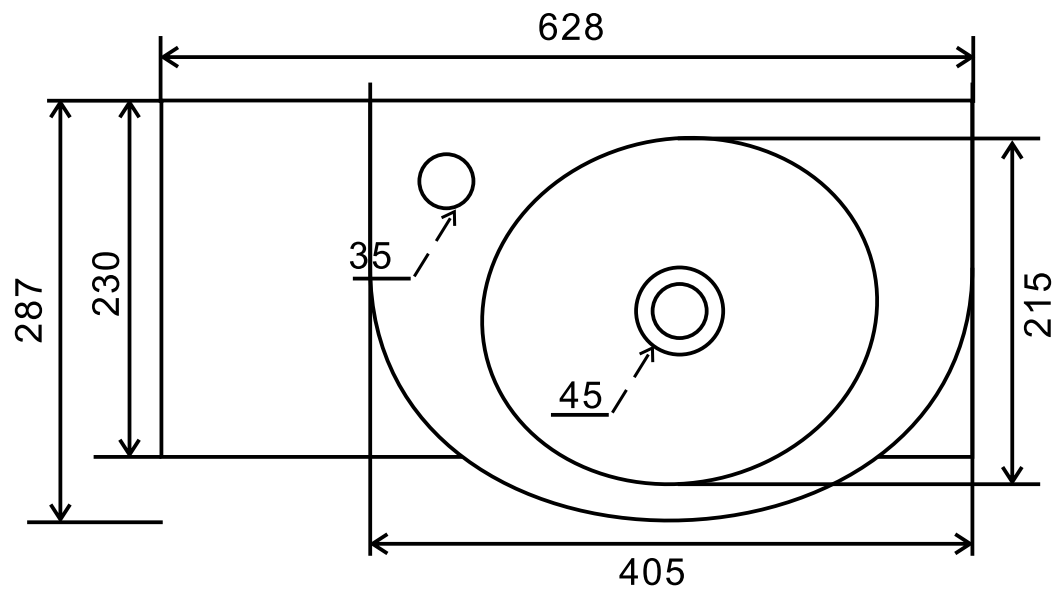

2023-7-21