

TR4153

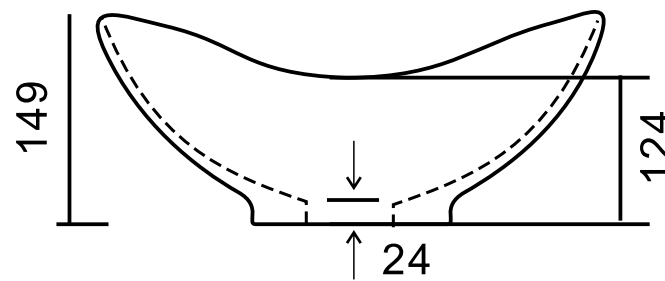
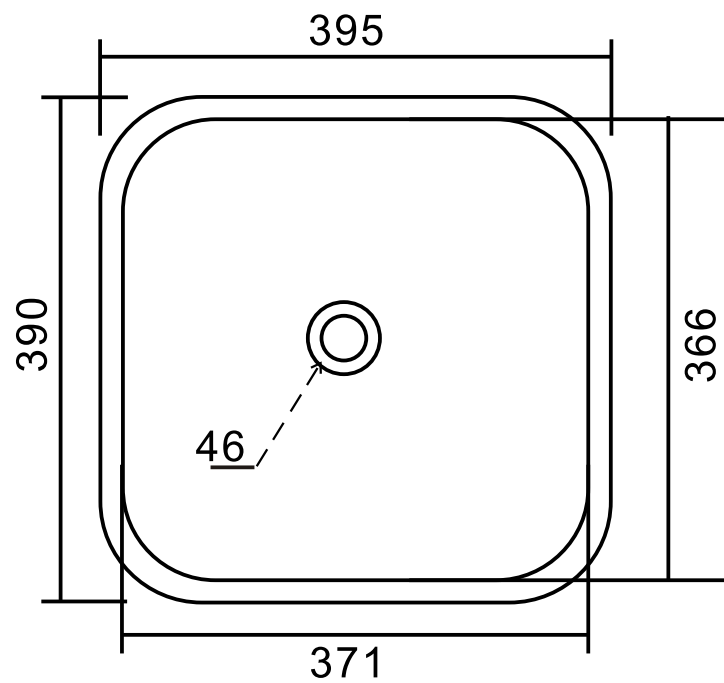

2023-7-22