

TR4414

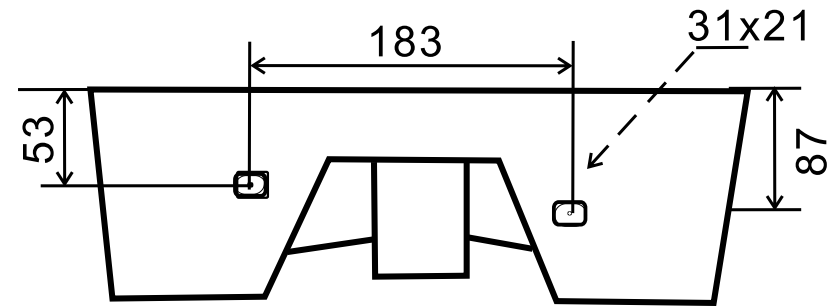
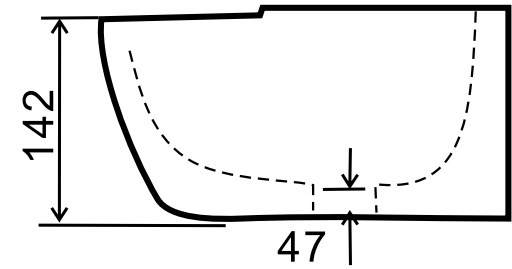
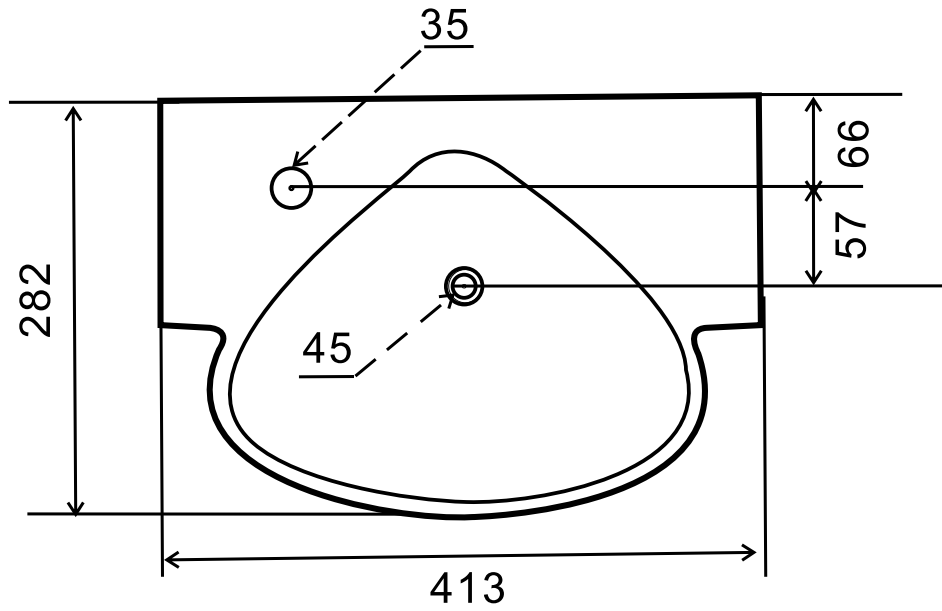

2023-7-22